

Micropto\_TOP

## LED bianchi SMD

LED ad emissione di luce bianca.

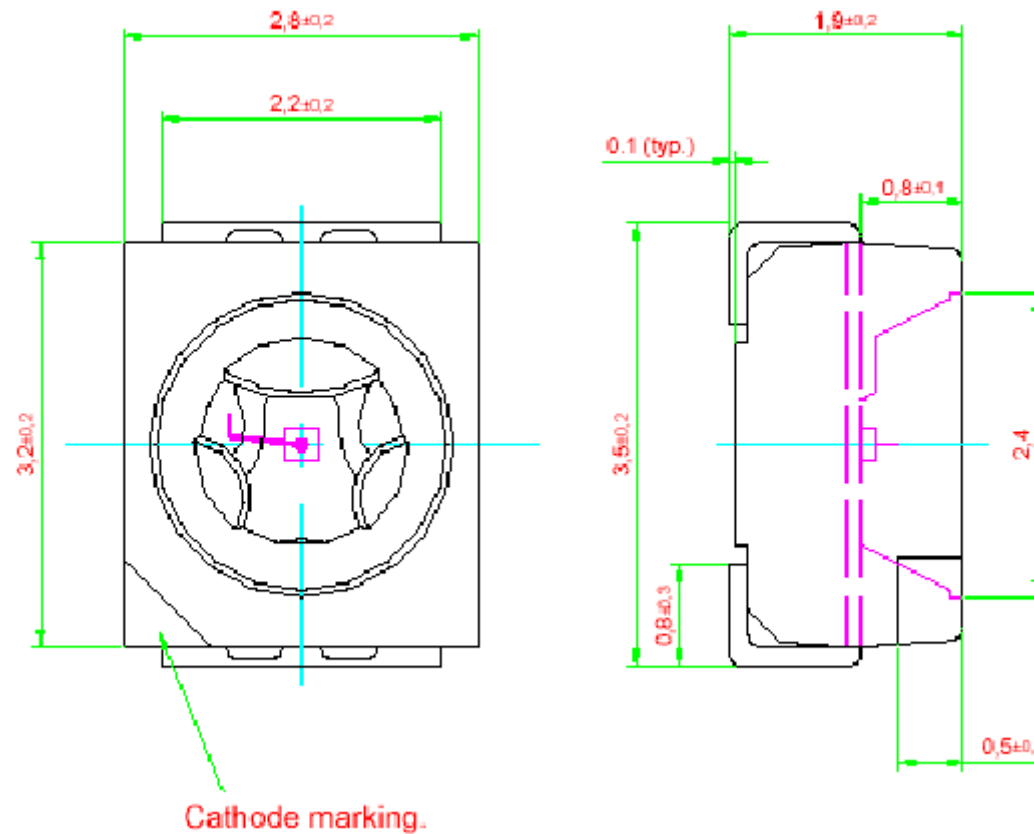

- High brightness surface mount LED

- 120° viewing angle
- Small package outline 2,8 mm x 3,2 mm x 1,8 mm (l x w x h).
- Qualified according with JEDEC moisture sensitivity level 2
- Compatible with both IR reflow soldering and TTW soldering

Part Ordering Number	Chip Technology / Color	Viewing angle	Luminous Intensity @If= 20mA Iv(mcd)
DDW-SJ2	<b>InGaN / Blue,460nm</b>	120°	800

**NOTE:**

1. All part number above comes in a quantity of 2000 units per reel.
2. Luminous intensity is measured with an accuracy of  $\pm 11\%$ .
3. Color selection acc to chromaticity coordinates groups.

Color	Group	Chromaticity Coordinate Group				
<b>DDW: White</b>	Full	x	0.26	0.26	0.35	0.35
		y	0.31	0.25	0.36	0.31
	W	x	0.26	0.26	0.29	0.29
		y	0.31	0.25	0.33	0.27
	X	x	0.29	0.29	0.32	0.32
		y	0.33	0.27	0.35	0.29
	Y	x	0.32	0.32	0.35	0.35
		y	0.35	0.29	0.37	0.31

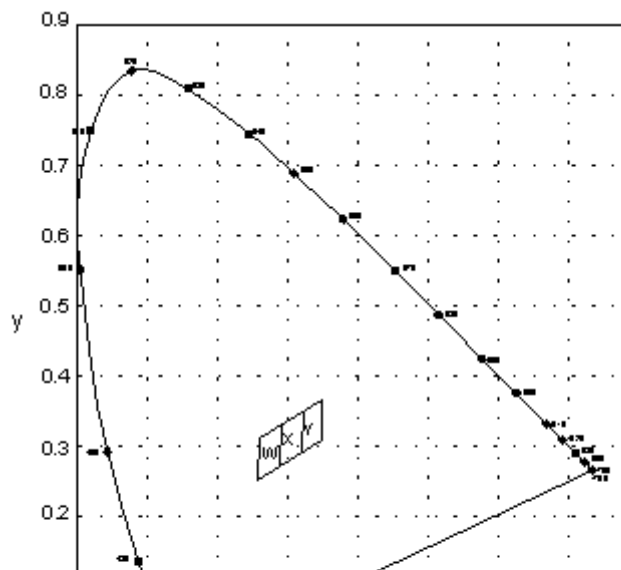

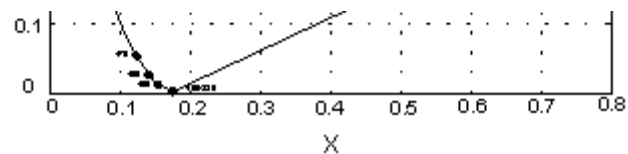

\* The C.I.E. 1931 chromaticity diagram

Chromaticity diagram

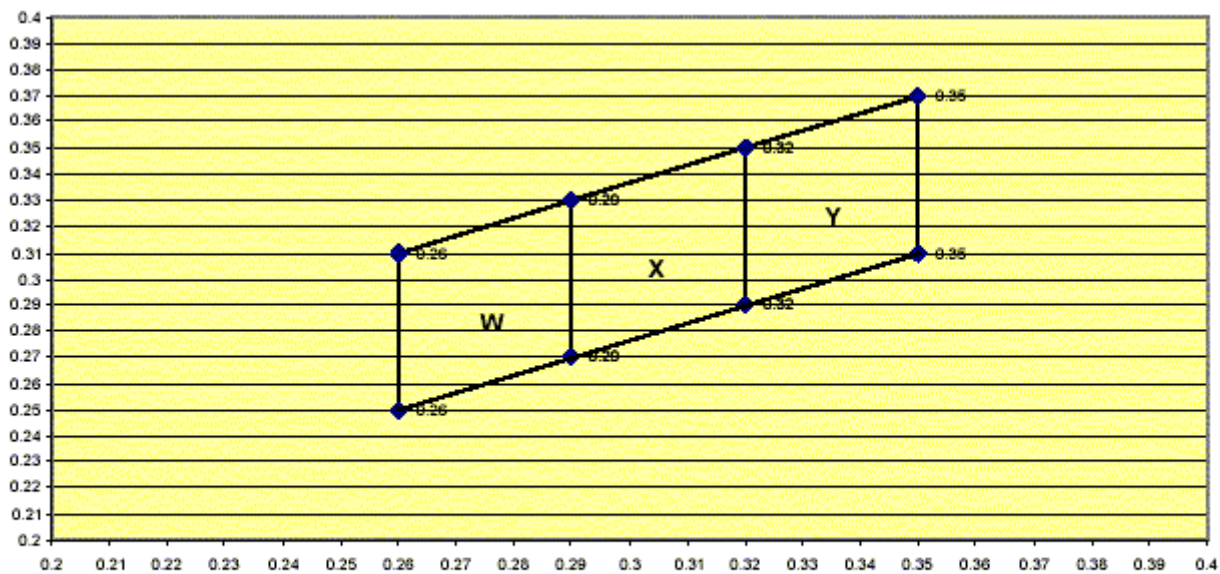

Chromaticity coordinate groups are measured with an accuracy of  $\pm 0.01$ .

**Vf Binning**

**Vf Bin @ 20 mA**

Standard

01

02

03

**Forwad voltage (V)**

3,35 - 4,25

3,35 - 3,65

3.65 - 3,95

3.95 - 4,25

Forward voltage Vf is measured with an accuracy of  $\pm 0,05$  V.

**Absolute Maximum Ratings.**

	<b>Maximum value</b>	<b>Unit</b>
DC forward current	20	mA
Peak pulse current (tp <= 10μS, Duty cycle = 0,005)	200	mA
Reverse voltage	5	V
LED junction temperature	125	°C
Operating temperature	-40 ... +100	°C
Storage temperature	-40 ... +100	°C
Power dissipation	80	mW

**Recommended solder pads**

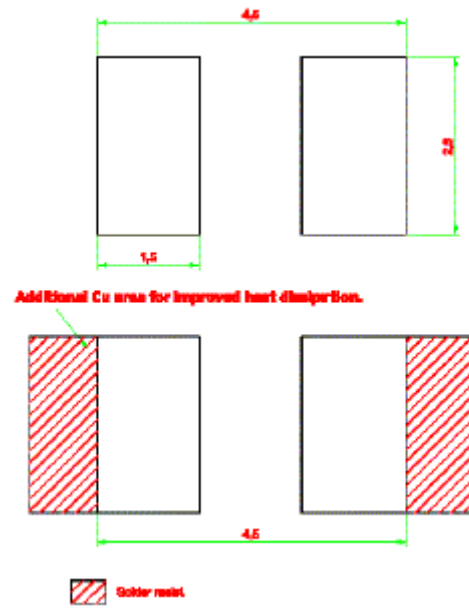

Dimensions: 4,5 mm (1,5x3) x 2,5 mm

### Relative Luminosity Intensity VS forward Current:

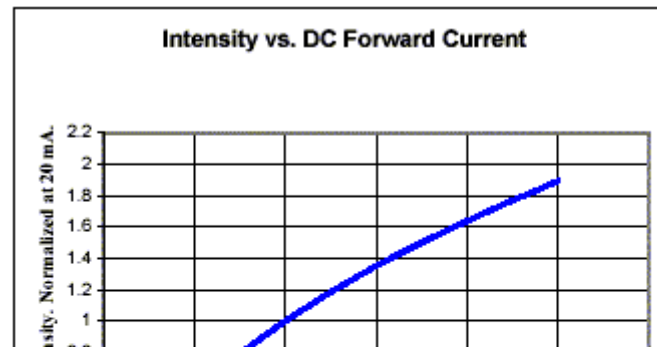

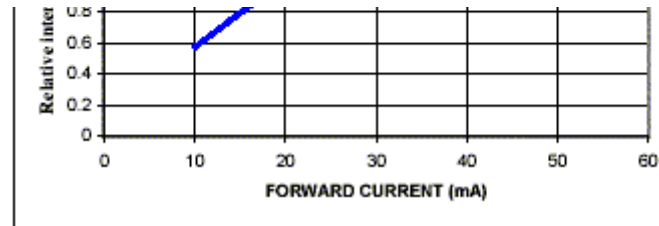

**Forward Current VS Forward Voltage:**

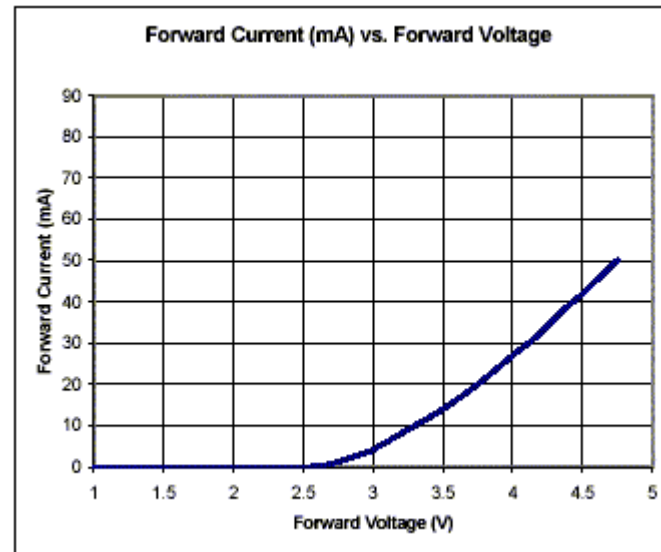

**Radiation Pattern:**

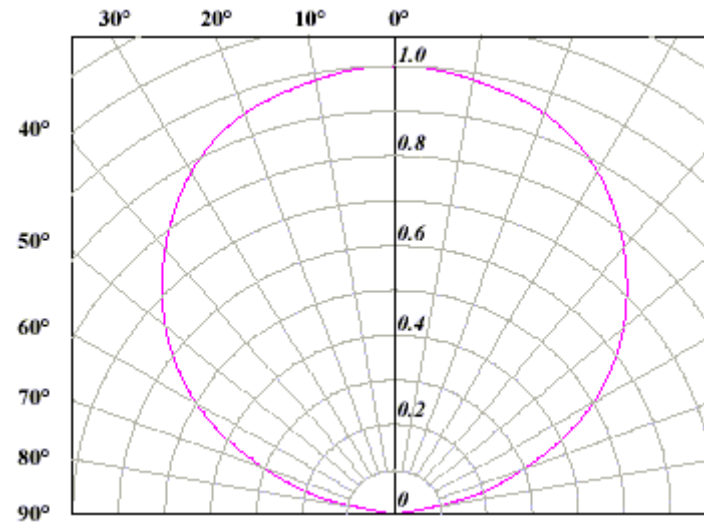

**Maximum Forward Current VS Temperature:**

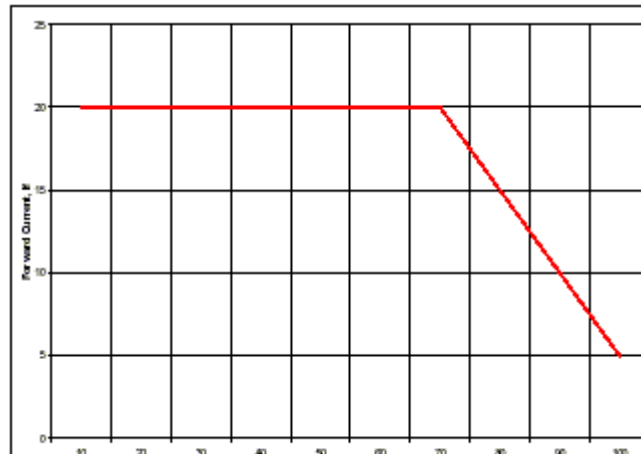





**BEWARE:** Specs under defining or improving.  
ATTENZIONE: specifiche in aggiornamento o in evoluzione.

[Torna a prodotti](#)

---

### Micropto S.r.l.

Via M. Melloni, 10  
20129 Milano (Italy)

Tel.: +39.02.76011848  
Fax: +39.02.76408519  
E.Mail: [welcome@micropto.com](mailto:welcome@micropto.com)  
Web: [www.micropto.com](http://www.micropto.com)

| [Prodotti](#) | [Chi siamo](#) | [Condizioni generali](#) | [FAQ](#) | [E.MAILS](#) | [Per scriverci](#) | [Per raggiungerci](#) | [Catalogo & Download](#) | [Novità](#) | [Fiere](#) | [Opportunità lavorative](#) | [Mappa del sito](#) | [Siti interessanti](#) | [Home](#) |  
[IT](#) - [UK/USA](#) - [DE](#)

Per informazioni tecniche sul sito: [WebMaster](#) per altre [informazioni](#).  
© 1999-2003 [Micropto](#) S.r.l. Tutti i diritti sono riservati.  
Mercoledì, 19 Novembre 2003